

Groene Serie

Voor modellen van de huidige generatie:

- | | |
|--------------------------|----------------------|
| Peddibasic No. 1 | Hydraulic 280 |
| Peddicat No. 1 | Hydraulic 502 |
| Peddiworker No. 1 | Hydraulic 801 |

Voor oudere modellen:

- Peddicat 361 • 380 • 500**
Peddiworker 501 • 502 • 801 • 802 • 1000 G
Peddimaster 100/160 • 110/170 • 800/1100 • 1100/1700
Peddimax 600 • 601 • 602 • 800 • 801 • 1002 • 110/140
Hydraulic 100 • 301 • 501 • 800 • 1000 • 1001
210 Super 16 • 20, 210 Standard 16
Forax 80 • 100 • 1000
225 B/16 • 20 • 80 • 100
225 H/15 • 20

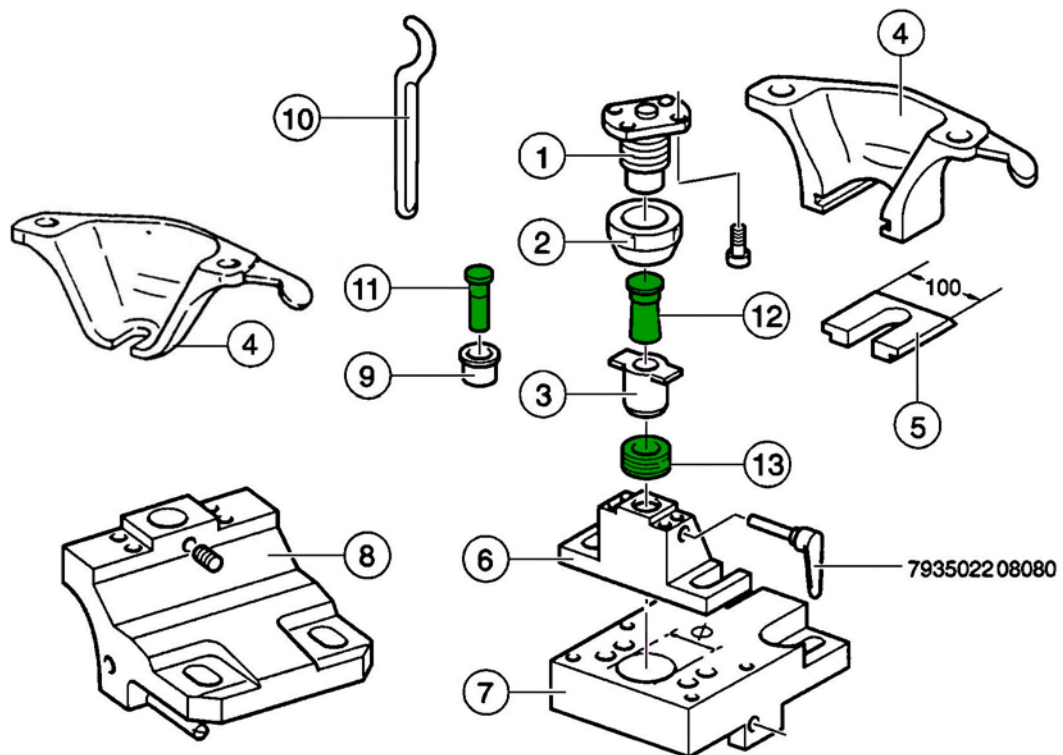

Stempels en matrijzen voor snelwissel-inrichting

Groene Serie

Rond stempel	Rond stempel	Rond matrijs	Rond matrijs	Excentrisch matrijs
Nr. 2	Nr. 5	Nr. 3	Nr. 3	Nr. 14
Bestelnr.	Bestelnr.	Bestelnr.	Bestelnr.	Bestelnr.
3,0 64002 1030 3,2 64002 1032 3,5 64002 1035 4,0 64002 1040 4,2 64002 1042 4,5 64002 1045 5,0 64002 1050 5,5 64002 1055 6,0 64002 1060 6,5 64002 1065 7,0 64002 1070 7,5 64002 1075 8,0 64002 1080 8,5 64002 1085 9,0 64002 1090 9,5 64002 1095 10,0 64002 1100 10,5 64002 1105 11,0 64002 1110 11,5 64002 1115 12,0 64002 1120 12,5 64002 1125 13,0 64002 1130 13,5 64002 1135 14,0 64002 1140 14,5 64002 1145 15,0 64002 1150 15,5 64002 1155 16,0 64002 1160 16,5 64002 1165 17,0 64002 1170 17,5 64002 1175 18,0 64002 1180 18,5 64002 1185 19,0 64002 1190	17,5 64005 1175 18,0 64005 1180 18,5 64005 1185 19,0 64005 1190 19,5 64005 1195 20,0 64005 1200 20,5 64005 1205 21,0 64005 1210 21,5 64005 1215 22,0 64005 1220 22,5 64005 1225 23,0 64005 1230 23,5 64005 1235 24,0 64005 1240 24,5 64005 1245 25,0 64005 1250 25,5 64005 1255 26,0 64005 1260 26,5 64005 1265 27,0 64005 1270 27,5 64005 1275 28,0 64005 1280 28,5 64005 1285 29,0 64005 1290 29,5 64005 1295 30,0 64005 1300 30,5 64005 1305 31,0 64005 1310 31,5 64005 1315 32,0 64005 1320	3,2 64203 1032 3,4 64203 1034 3,7 64203 1037 4,2 64203 1042 4,4 64203 1044 4,7 64203 1047 5,2 64203 1052 5,7 64203 1057 6,2 64203 1062 6,7 64203 1067 7,2 64203 1072 7,7 64203 1077 8,2 64203 1082 8,7 64203 1087 9,2 64203 1092 9,7 64203 1097 10,2 64203 1102 10,7 64203 1107 11,2 64203 1112 11,7 64203 1117 12,2 64203 1122 12,7 64203 1127 13,2 64203 1132 13,7 64203 1137 14,2 64203 1142 14,7 64203 1147 15,2 64203 1152 15,7 64203 1157 16,2 64203 1162 16,7 64203 1167 17,2 64203 1172 17,7 64203 1177 18,2 64203 1182 18,7 64203 1187 19,2 64203 1192 19,7 64203 1197	20,2 64203 1202 20,7 64203 1207 21,2 64203 1212 21,7 64203 1217 22,2 64203 1222 22,7 64203 1227 23,2 64203 1232 23,7 64203 1237 24,2 64203 1242 24,7 64203 1247 25,2 64203 1252 25,7 64203 1257 26,2 64203 1262 26,7 64203 1267 27,2 64203 1272 27,7 64203 1277 28,2 64203 1282 28,7 64203 1287 29,2 64203 1292 29,7 64203 1297 30,2 64203 1302 30,7 64203 1307 31,2 64203 1312 31,7 64203 1317 32,2 64203 1322 32,7 64203 1327 33,2 64203 1332	5,7 64214 1057 6,2 64214 1062 6,7 64214 1067 7,2 64214 1072 7,7 64214 1077 8,2 64214 1082 8,7 64214 1087 9,2 64214 1092 9,7 64214 1097 10,2 64214 1102 10,7 64214 1107 11,2 64214 1112 11,7 64214 1117 12,2 64214 1122 12,7 64214 1127 13,2 64214 1132 13,7 64214 1137 14,2 64214 1142 14,7 64214 1147 15,2 64214 1152 15,7 64214 1157 16,2 64214 1162 16,7 64214 1167 17,2 64214 1172 17,7 64214 1177 18,2 64214 1182 18,7 64214 1187 19,2 64214 1192 19,7 64214 1197 20,2 64214 1202 20,7 64214 1207 21,2 64214 1212 21,7 64214 1217 22,2 64214 1222 22,7 64214 1227 23,2 64214 1232 23,7 64214 1237 24,2 64214 1242 24,7 64214 1247





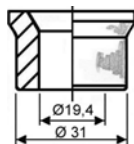

Reducerhuls 2/5



44081 198 503

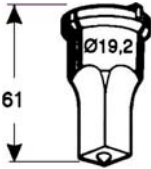
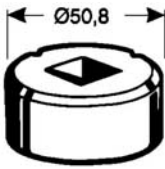
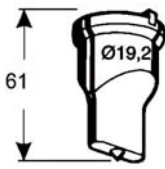
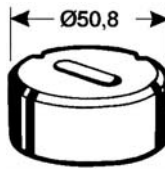

Groene Serie

Vierkant stempel		Vierkant matrijs		Langgat stempel		Langgat matrijs	
Nr. 2		Nr. 3		Nr. 2		Nr. 3	
							
	Bestelnr.		Bestelnr.		Bestelnr.		Bestelnr.
4,0	64002 2040	4,2	64203 2042	5,0 × 10,0	64002 3 050100	5,2 × 10,2	64203 3 052102
5,0	64002 2050	5,2	64203 2052			5,7 × 10,7	64203 3 057107
6,0	64002 2060	6,2	64203 2062	5,0 × 14,0	64002 3 050140	5,2 × 14,2	64203 3 052142
7,0	64002 2070	6,7	64203 2067			5,7 × 14,7	64203 3 057147
8,0	64002 2080	7,2	64203 2072	5,5 × 10,0	64002 3 055100	5,7 × 10,2	64203 3 057102
9,0	64002 2090	7,7	64203 2077			6,2 × 10,7	64203 3 062107
10,0	64002 2100	8,2	64203 2082	5,5 × 14,0	64002 3 055140	5,7 × 14,2	64203 3 057142
11,0	64002 2110	8,7	64203 2087			6,2 × 14,7	64203 3 062147
12,0	64002 2120	9,2	64203 2092	5,5 × 19,0	64002 3 055190	5,7 × 19,2	64203 3 057192
13,0	64002 2130	9,7	64203 2097			6,2 × 19,7	64203 3 062197
		10,2	64203 2102	6,5 × 12,0	64002 3 065120	6,7 × 12,2	64203 3 067122
		10,7	64203 2107			7,2 × 12,7	64203 3 072127
		11,2	64203 2112	6,5 × 18,0	64002 3 065180	6,7 × 18,2	64203 3 067182
		11,7	64203 2117			7,2 × 18,7	64203 3 072187
		12,2	64203 2122	7,5 × 14,0	64002 3 075140	7,7 × 14,2	64203 3 077142
		12,7	64203 2127			8,2 × 14,7	64203 3 082147
		13,2	64203 2132	9,0 × 14,0	64002 3 090140	9,2 × 14,2	64203 3 092142
		13,7	64203 2137			9,7 × 14,7	64203 3 097147
		14,2	64203 2142	9,0 × 18,0	64002 3 090180	9,2 × 18,2	64203 3 092182
		14,7	64203 2147			9,7 × 18,7	64203 3 097187
		15,2	64203 2152	10,0 × 14,0	64002 3 100140	10,2 × 14,2	64203 3 102142
		15,7	64203 2157			10,7 × 14,7	64203 3 107147
		16,2	64203 2162			11,2 × 15,2	64203 3 112152
		16,7	64203 2167				
		17,2	64203 2172				
		17,7	64203 2177				
		18,2	64203 2182				
		18,7	64203 2187				
		19,2	64203 2192				
		19,7	64203 2197				
		20,2	64203 2202				
		20,7	64203 2207				
		21,2	64203 2212				
		21,7	64203 2217				
		22,2	64203 2222				
		22,7	64203 2227				
		23,2	64203 2232				
		23,7	64203 2237				

Vierkant stempel

Nr. 5

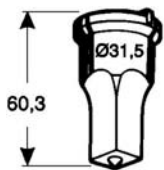

Bestelnr.

14,0	64005 2140
15,0	64005 2150
16,0	64005 2160
17,0	64005 2170
18,0	64005 2180
19,0	64005 2190
20,0	64005 2200
21,0	64005 2210
22,0	64005 2220

Materiaaldikte:	Snijspeling:
tot 4 mm	0,2 mm
4 – 9 mm	0,7 mm
9 – 14 mm	1,2 mm

Groene Serie

Langgat stempel		Langgat matrijs		Langgat stempel		Langgat matrijs	
Nr. 5		Nr. 3		Nr. 5		Nr. 3	
	Bestelnr.		Bestelnr.		Bestelnr.		Bestelnr.
5,5 × 25,0	64005 3 055250	5,7 × 25,2 6,2 × 25,7	64203 3 057252 64203 3 062257	12,0 × 24,0	64005 3 120240	12,2 × 24,2 12,7 × 24,7 13,2 × 25,2	64203 3 122242 64203 3 127247 64203 3 132252
6,5 × 26,0	64005 3 065260	6,7 × 26,2 7,2 × 26,7	64203 3 067262 64203 3 072267	12,0 × 30,0	64005 3 120300	12,2 × 30,2 12,7 × 30,7 13,2 × 31,2	64203 3 122302 64203 3 127307 64203 3 132312
6,5 × 30,0	64005 3 065300	6,7 × 30,2 7,2 × 30,7	64203 3 067302 64203 3 072307	13,0 × 26,0	64005 3 130260	13,2 × 26,2 13,7 × 26,7 14,2 × 27,2	64203 3 132262 64203 3 137267 64203 3 142272
7,5 × 21,0	64005 3 075210	7,7 × 21,2 8,2 × 21,7	64203 3 077212 64203 3 082217	13,0 × 30,0	64005 3 130300	13,2 × 30,2 13,7 × 30,7 14,2 × 31,2	64203 3 132302 64203 3 137307 64203 3 142312
7,5 × 26,0	64005 3 075260	7,7 × 26,2 8,2 × 26,7	64203 3 077262 64203 3 082267	14,0 × 26,0	64005 3 140260	14,2 × 26,2 14,7 × 26,7 15,2 × 27,2	64203 3 142262 64203 3 147267 64203 3 152272
7,5 × 30,0	64005 3 075300	7,7 × 30,2 8,2 × 30,7	64203 3 077302 64203 3 082307	14,0 × 28,0	64005 3 140280	14,2 × 28,2 14,7 × 28,7 15,2 × 29,2	64203 3 142282 64203 3 147287 64203 3 152292
9,0 × 26,0	64005 3 090260	9,2 × 26,2 9,7 × 26,7	64203 3 092262 64203 3 097267	16,0 × 26,0	64005 3 160260	16,2 × 26,2 16,7 × 26,7 17,2 × 27,2	64203 3 162262 64203 3 167267 64203 3 172272
9,0 × 30,0	64005 3 090300	9,2 × 30,2 9,7 × 30,7	64203 3 092302 64203 3 097307	16,0 × 31,0	64005 3 160310	16,2 × 31,2 16,7 × 31,7 17,2 × 32,2	64203 3 162312 64203 3 167317 64203 3 172322
10,0 × 20,0	64005 3 100200	10,2 × 20,2 10,7 × 20,7 11,2 × 21,2	64203 3 102202 64203 3 107207 64203 3 112212	18,0 × 26,0	64005 3 180260	18,2 × 26,2 18,7 × 26,7 19,2 × 27,2	64203 3 182262 64203 3 187267 64203 3 192272
10,0 × 26,0	64005 3 100260	10,2 × 26,2 10,7 × 26,7 11,2 × 27,2	64203 3 102262 64203 3 107267 64203 3 112272	18,0 × 31,0	64005 3 180310	18,2 × 31,2 18,7 × 31,7 19,2 × 32,2	64203 3 182312 64203 3 187317 64203 3 192322
10,0 × 30,0	64005 3 100300	10,2 × 30,2 10,7 × 30,7 11,2 × 31,2	64203 3 102302 64203 3 107307 64203 3 112312	20,0 × 31,0	64005 3 200310	20,2 × 31,2 20,7 × 31,7 21,2 × 32,2	64203 3 202312 64203 3 207317 64203 3 212322
11,0 × 22,0	64005 3 110220	11,2 × 22,2 11,7 × 22,7 12,2 × 23,2	64203 3 112222 64203 3 117227 64203 3 122232	22,0 × 31,0	64005 3 220310	22,2 × 31,2 22,7 × 31,7 23,2 × 32,2	64203 3 222312 64203 3 227317 64203 3 232322
11,0 × 26,0	64005 3 110260	11,2 × 26,2 11,7 × 26,7 12,2 × 27,2	64203 3 112262 64203 3 117267 64203 3 122272				
11,0 × 30,0	64005 3 110300	11,2 × 30,2 11,7 × 30,7 12,2 × 31,2	64203 3 112302 64203 3 117307 64203 3 122312				

Snijspeling: : **0,2 mm** (Materiaaldikte: tot 4 mm) • **0,7 mm** (Materiaaldikte: 4 tot 9 mm) • **1,2 mm** (Materiaaldikte: 9 tot 14 mm)

Groene Serie

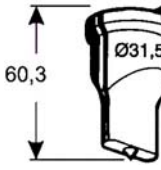
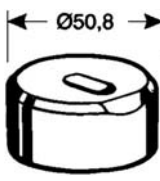
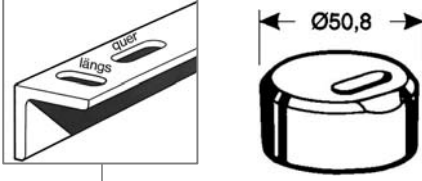
Langgat stempel	Langgat stempel	Excentrisch matrijs langgat langs	Excentrisch matrijs langgat dwars
Nr. 2	Nr. 5	Nr. 14	Nr. 14
			
Bestelnr.	Bestelnr.	Bestelnr.	Bestelnr.
5,5 × 14,0 64002 3 055140	5,5 × 25,0 64005 3 055250 6,5 × 26,0 64005 3 065260 7,5 × 26,0 64005 3 075260	6,2 × 14,7 64214 3 062147 6,2 × 25,7 64214 3 062257 7,2 × 26,7 64214 3 072267 8,2 × 26,7 64214 3 082267 9,7 × 14,7 64214 3 097147 9,7 × 26,7 64214 3 097267 10,7 × 20,7 64214 3 107207 11,7 × 22,7 64214 3 117227 11,7 × 26,7 64214 3 117267 13,7 × 26,7 64214 3 137267 14,7 × 26,7 64214 3 147267 16,7 × 26,7 64214 3 167267	6,2 × 14,7 64214 4 062147 6,2 × 25,7 64214 4 062257 7,2 × 26,7 64214 4 072267 8,2 × 26,7 64214 4 082267 9,7 × 14,7 64214 4 097147 9,7 × 26,7 64214 4 097267 10,7 × 20,7 64214 4 107207 11,7 × 22,7 64214 4 117227 11,7 × 26,7 64214 4 117267 13,7 × 26,7 64214 4 137267 14,7 × 26,7 64214 4 147267 16,7 × 26,7 64214 4 167267
9,0 × 14,0 64002 3 090140	9,0 × 26,0 64005 3 090260 10,0 × 20,0 64005 3 100200 11,0 × 22,0 64005 3 110220 11,0 × 26,0 64005 3 110260 13,0 × 26,0 64005 3 130260 14,0 × 26,0 64005 3 140260 16,0 × 26,0 64005 3 160260		









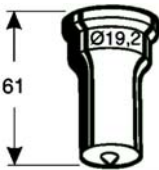
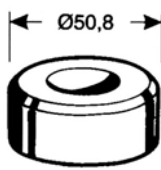
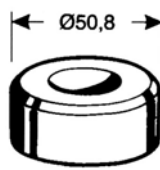
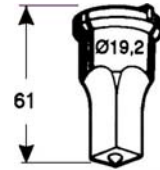

Groene Serie

Rechthoek stempel		Rechthoek matrijs		Sleutelgat stempel*		Sleutelgat matrijs			
Nr. 5		Nr. 3		Nr. 5		Nr. 3			
	Bestelnr.		Bestelnr.		Bestelnr.		Bestelnr.		
5,0 × 15	64005 5 050150	5,2 × 15,2	64203 5 052152	34,0 × Ø17,5 × 10,5 65005 17001 * Hiervoor is nodig: Snelspaninzet - sleutelgat tbv stempel-snelwissel-inrichting – groene serie – v. a. 1993 vor 1993: Snelspaninzet - sleutelgat	 42217 6 2002 02 P-44081 6 2005 01	5,7 × 15,7	64203 5 057157		
5,0 × 20	64005 5 050200	5,2 × 20,2	64203 5 052202			34,2 × Ø17,7 × 10,7	65203 17001	5,7 × 20,7	64203 5 057207
6,0 × 24	64005 5 060240	6,2 × 24,2	64203 5 062242					6,2 × 24,2	64203 5 062242
8,0 × 16	64005 5 080160	8,2 × 16,2	64203 5 082162					6,7 × 24,7	64203 5 067247
8,0 × 24	64005 5 080240	8,7 × 16,7	64203 5 087167					8,2 × 16,2	64203 5 082162
9,0 × 24	64005 5 090240	8,2 × 24,2	64203 5 082242					8,7 × 16,7	64203 5 087167
10,0 × 20	64005 5 100200	8,7 × 24,7	64203 5 087247					8,2 × 24,2	64203 5 082242
11,0 × 22	64005 5 110220	9,2 × 24,2	64203 5 092242					9,7 × 24,7	64203 5 097247
12,0 × 22	64005 5 120220	9,7 × 24,7	64203 5 097247					10,2 × 20,2	64203 5 102202
12,0 × 30	64005 5 120300	10,2 × 20,2	64203 5 102202					10,7 × 20,7	64203 5 107207
14,0 × 20	64005 5 140200	10,7 × 20,7	64203 5 107207					11,2 × 22,2	64203 5 112222
16,0 × 20	64005 5 160200	11,2 × 22,2	64203 5 112222					11,7 × 22,7	64203 5 117227
		11,7 × 22,7	64203 5 117227					12,2 × 22,2	64203 5 122222
		12,2 × 22,2	64203 5 122222					12,7 × 22,7	64203 5 127227
		12,7 × 22,7	64203 5 127227					12,2 × 30,2	64203 5 122302
		12,2 × 30,2	64203 5 122302					12,7 × 30,7	64203 5 127307
		12,7 × 30,7	64203 5 127307					14,2 × 20,2	64203 5 142202
		14,2 × 20,2	64203 5 142202			14,7 × 20,7	64203 5 147207		
		14,7 × 20,7	64203 5 147207			16,2 × 20,2	64203 5 162202		
		16,2 × 20,2	64203 5 162202			16,7 × 20,7	64203 5 167207		
		16,7 × 20,7	64203 5 167207						

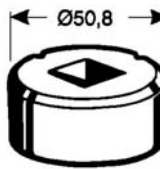
Hoekaf rond stempel		Hoekaf rond matrijs		Spanjolet stempel		Spanjolet matrijs	
Nr. 5		Nr. 3		Nr. 5		Nr. 3	
	Bestelnr.		Bestelnr.		Bestelnr.		Bestelnr.
Radius		Radius		Ø 22,2 × 20,3	65005 38 222203	Ø 22,4 × 20,5	65203 38 224205
5	65005 37 00050	5	65203 37 00050				
10	65005 37 00100	10	65203 37 00100				
14	65005 37 00140	14	65203 37 00140				
15	65005 37 00150	15	65203 37 00150				

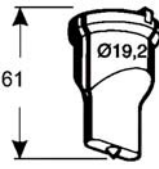
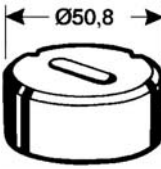
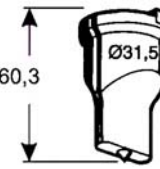
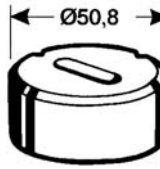
Groene Serie

Speciale stempels voor ponsen in RVS

Rond stempel, speciaal	Rond matrijs (standaard)	Rond matrijs (standaard)	Vierkant stempel speciaal																																																																																																		
Nr. 2	Nr. 3	Nr. 3	Nr. 2																																																																																																		
																																																																																																					
 Bestelnr.	 Bestelnr.	 Bestelnr.	 Bestelnr.																																																																																																		
<table style="width: 100%; border-collapse: collapse;"> <tr><td style="text-align: right; padding-right: 10px;">3,0</td><td>P-65002 8012 030</td></tr> <tr><td style="text-align: right; padding-right: 10px;">4,0</td><td>P-65002 8012 040</td></tr> <tr><td style="text-align: right; padding-right: 10px;">4,5</td><td>P-65002 8012 045</td></tr> <tr><td style="text-align: right; padding-right: 10px;">5,0</td><td>P-65002 8012 050</td></tr> <tr><td style="text-align: right; padding-right: 10px;">5,5</td><td>P-65002 8012 055</td></tr> <tr><td style="text-align: right; padding-right: 10px;">6,0</td><td>P-65002 8012 060</td></tr> <tr><td style="text-align: right; padding-right: 10px;">6,5</td><td>P-65002 8012 065</td></tr> <tr><td style="text-align: right; padding-right: 10px;">7,0</td><td>P-65002 8012 070</td></tr> <tr><td style="text-align: right; padding-right: 10px;">8,0</td><td>P-65002 8012 080</td></tr> <tr><td style="text-align: right; padding-right: 10px;">9,0</td><td>P-65002 8012 090</td></tr> <tr><td style="text-align: right; padding-right: 10px;">10,0</td><td>P-65002 8012 100</td></tr> <tr><td style="text-align: right; padding-right: 10px;">11,0</td><td>P-65002 8012 110</td></tr> <tr><td style="text-align: right; padding-right: 10px;">12,0</td><td>P-65002 8012 120</td></tr> <tr><td style="text-align: right; padding-right: 10px;">13,0</td><td>P-65002 8012 130</td></tr> <tr><td style="text-align: right; padding-right: 10px;">14,0</td><td>P-65002 8012 140</td></tr> <tr><td style="text-align: right; padding-right: 10px;">15,0</td><td>P-65002 8012 150</td></tr> <tr><td style="text-align: right; padding-right: 10px;">16,0</td><td>P-65002 8012 160</td></tr> <tr><td style="text-align: right; padding-right: 10px;">17,0</td><td>P-65002 8012 170</td></tr> </table>	3,0	P-65002 8012 030	4,0	P-65002 8012 040	4,5	P-65002 8012 045	5,0	P-65002 8012 050	5,5	P-65002 8012 055	6,0	P-65002 8012 060	6,5	P-65002 8012 065	7,0	P-65002 8012 070	8,0	P-65002 8012 080	9,0	P-65002 8012 090	10,0	P-65002 8012 100	11,0	P-65002 8012 110	12,0	P-65002 8012 120	13,0	P-65002 8012 130	14,0	P-65002 8012 140	15,0	P-65002 8012 150	16,0	P-65002 8012 160	17,0	P-65002 8012 170	<table style="width: 100%; border-collapse: collapse;"> <tr><td style="text-align: right; padding-right: 10px;">3,2</td><td>64203 1032</td></tr> <tr><td style="text-align: right; padding-right: 10px;">3,7</td><td>64203 1037</td></tr> <tr><td style="text-align: right; padding-right: 10px;">4,2</td><td>64203 1042</td></tr> <tr><td style="text-align: right; padding-right: 10px;">4,7</td><td>64203 1047</td></tr> <tr><td style="text-align: right; padding-right: 10px;">5,2</td><td>64203 1052</td></tr> <tr><td style="text-align: right; padding-right: 10px;">5,7</td><td>64203 1057</td></tr> <tr><td style="text-align: right; padding-right: 10px;">6,2</td><td>64203 1062</td></tr> <tr><td style="text-align: right; padding-right: 10px;">6,7</td><td>64203 1067</td></tr> <tr><td style="text-align: right; padding-right: 10px;">7,2</td><td>64203 1072</td></tr> <tr><td style="text-align: right; padding-right: 10px;">7,7</td><td>64203 1077</td></tr> <tr><td style="text-align: right; padding-right: 10px;">8,2</td><td>64203 1082</td></tr> <tr><td style="text-align: right; padding-right: 10px;">8,7</td><td>64203 1087</td></tr> <tr><td style="text-align: right; padding-right: 10px;">9,2</td><td>64203 1092</td></tr> <tr><td style="text-align: right; padding-right: 10px;">9,7</td><td>64203 1097</td></tr> <tr><td style="text-align: right; padding-right: 10px;">10,2</td><td>64203 1102</td></tr> <tr><td style="text-align: right; padding-right: 10px;">10,7</td><td>64203 1107</td></tr> <tr><td style="text-align: right; padding-right: 10px;">11,2</td><td>64203 1112</td></tr> <tr><td style="text-align: right; padding-right: 10px;">11,7</td><td>64203 1117</td></tr> </table>	3,2	64203 1032	3,7	64203 1037	4,2	64203 1042	4,7	64203 1047	5,2	64203 1052	5,7	64203 1057	6,2	64203 1062	6,7	64203 1067	7,2	64203 1072	7,7	64203 1077	8,2	64203 1082	8,7	64203 1087	9,2	64203 1092	9,7	64203 1097	10,2	64203 1102	10,7	64203 1107	11,2	64203 1112	11,7	64203 1117	<table style="width: 100%; border-collapse: collapse;"> <tr><td style="text-align: right; padding-right: 10px;">12,2</td><td>64203 1122</td></tr> <tr><td style="text-align: right; padding-right: 10px;">12,7</td><td>64203 1127</td></tr> <tr><td style="text-align: right; padding-right: 10px;">13,2</td><td>64203 1132</td></tr> <tr><td style="text-align: right; padding-right: 10px;">13,7</td><td>64203 1137</td></tr> <tr><td style="text-align: right; padding-right: 10px;">14,2</td><td>64203 1142</td></tr> <tr><td style="text-align: right; padding-right: 10px;">14,7</td><td>64203 1147</td></tr> <tr><td style="text-align: right; padding-right: 10px;">15,2</td><td>64203 1152</td></tr> <tr><td style="text-align: right; padding-right: 10px;">15,7</td><td>64203 1157</td></tr> <tr><td style="text-align: right; padding-right: 10px;">16,2</td><td>64203 1162</td></tr> <tr><td style="text-align: right; padding-right: 10px;">16,7</td><td>64203 1167</td></tr> <tr><td style="text-align: right; padding-right: 10px;">17,2</td><td>64203 1172</td></tr> <tr><td style="text-align: right; padding-right: 10px;">17,7</td><td>64203 1177</td></tr> <tr><td style="text-align: right; padding-right: 10px;">18,2</td><td>64203 1182</td></tr> </table>	12,2	64203 1122	12,7	64203 1127	13,2	64203 1132	13,7	64203 1137	14,2	64203 1142	14,7	64203 1147	15,2	64203 1152	15,7	64203 1157	16,2	64203 1162	16,7	64203 1167	17,2	64203 1172	17,7	64203 1177	18,2	64203 1182	<p style="text-align: center;">9,0 P-65002 8014 090</p> <p style="text-align: center;">Vierkant matrijs (standaard)</p> <div style="background-color: #008000; color: white; text-align: center; padding: 5px;">Nr. 3</div> <div style="text-align: center;"></div> <div style="text-align: center;"> Bestelnr.</div> <p style="text-align: center;">9,7 64203 2097</p>
3,0	P-65002 8012 030																																																																																																				
4,0	P-65002 8012 040																																																																																																				
4,5	P-65002 8012 045																																																																																																				
5,0	P-65002 8012 050																																																																																																				
5,5	P-65002 8012 055																																																																																																				
6,0	P-65002 8012 060																																																																																																				
6,5	P-65002 8012 065																																																																																																				
7,0	P-65002 8012 070																																																																																																				
8,0	P-65002 8012 080																																																																																																				
9,0	P-65002 8012 090																																																																																																				
10,0	P-65002 8012 100																																																																																																				
11,0	P-65002 8012 110																																																																																																				
12,0	P-65002 8012 120																																																																																																				
13,0	P-65002 8012 130																																																																																																				
14,0	P-65002 8012 140																																																																																																				
15,0	P-65002 8012 150																																																																																																				
16,0	P-65002 8012 160																																																																																																				
17,0	P-65002 8012 170																																																																																																				
3,2	64203 1032																																																																																																				
3,7	64203 1037																																																																																																				
4,2	64203 1042																																																																																																				
4,7	64203 1047																																																																																																				
5,2	64203 1052																																																																																																				
5,7	64203 1057																																																																																																				
6,2	64203 1062																																																																																																				
6,7	64203 1067																																																																																																				
7,2	64203 1072																																																																																																				
7,7	64203 1077																																																																																																				
8,2	64203 1082																																																																																																				
8,7	64203 1087																																																																																																				
9,2	64203 1092																																																																																																				
9,7	64203 1097																																																																																																				
10,2	64203 1102																																																																																																				
10,7	64203 1107																																																																																																				
11,2	64203 1112																																																																																																				
11,7	64203 1117																																																																																																				
12,2	64203 1122																																																																																																				
12,7	64203 1127																																																																																																				
13,2	64203 1132																																																																																																				
13,7	64203 1137																																																																																																				
14,2	64203 1142																																																																																																				
14,7	64203 1147																																																																																																				
15,2	64203 1152																																																																																																				
15,7	64203 1157																																																																																																				
16,2	64203 1162																																																																																																				
16,7	64203 1167																																																																																																				
17,2	64203 1172																																																																																																				
17,7	64203 1177																																																																																																				
18,2	64203 1182																																																																																																				
Langgat stempel, speciaal	Langgat matrijs (standaard)	Langgat stempel, speciaal	Langgat matrijs (standaard)																																																																																																		
Nr. 2	Nr. 3	Nr. 5	Nr. 3																																																																																																		
																																																																																																					
 Bestelnr.	 Bestelnr.	 Bestelnr.	 Bestelnr.																																																																																																		
<table style="width: 100%; border-collapse: collapse;"> <tr><td style="text-align: right; padding-right: 10px;">9,0 × 14,0</td><td>P-65002 8013 01</td></tr> <tr><td style="text-align: right; padding-right: 10px;">9,0 × 18,0</td><td>P-65002 8013 03</td></tr> </table>	9,0 × 14,0	P-65002 8013 01	9,0 × 18,0	P-65002 8013 03	<table style="width: 100%; border-collapse: collapse;"> <tr><td style="text-align: right; padding-right: 10px;">9,7 × 14,7</td><td>64203 3 097147</td></tr> <tr><td style="text-align: right; padding-right: 10px;">9,7 × 18,7</td><td>64203 3 097187</td></tr> </table>	9,7 × 14,7	64203 3 097147	9,7 × 18,7	64203 3 097187	<table style="width: 100%; border-collapse: collapse;"> <tr><td style="text-align: right; padding-right: 10px;">10,0 × 30,0</td><td>P-65005 8024 01</td></tr> <tr><td style="text-align: right; padding-right: 10px;">11,0 × 26,0</td><td>P-65005 8024 04</td></tr> <tr><td style="text-align: right; padding-right: 10px;">11,0 × 30,0</td><td>P-65005 8024 03</td></tr> </table>	10,0 × 30,0	P-65005 8024 01	11,0 × 26,0	P-65005 8024 04	11,0 × 30,0	P-65005 8024 03	<table style="width: 100%; border-collapse: collapse;"> <tr><td style="text-align: right; padding-right: 10px;">10,7 × 30,7</td><td>64203 3 107307</td></tr> <tr><td style="text-align: right; padding-right: 10px;">11,2 × 31,2</td><td>64203 3 112312</td></tr> <tr><td style="text-align: right; padding-right: 10px;">11,7 × 26,7</td><td>64203 3 117267</td></tr> <tr><td style="text-align: right; padding-right: 10px;">12,2 × 27,2</td><td>64203 3 122272</td></tr> <tr><td style="text-align: right; padding-right: 10px;">11,7 × 30,7</td><td>64203 3 117307</td></tr> <tr><td style="text-align: right; padding-right: 10px;">12,2 × 31,2</td><td>64203 3 122312</td></tr> </table>	10,7 × 30,7	64203 3 107307	11,2 × 31,2	64203 3 112312	11,7 × 26,7	64203 3 117267	12,2 × 27,2	64203 3 122272	11,7 × 30,7	64203 3 117307	12,2 × 31,2	64203 3 122312																																																																								
9,0 × 14,0	P-65002 8013 01																																																																																																				
9,0 × 18,0	P-65002 8013 03																																																																																																				
9,7 × 14,7	64203 3 097147																																																																																																				
9,7 × 18,7	64203 3 097187																																																																																																				
10,0 × 30,0	P-65005 8024 01																																																																																																				
11,0 × 26,0	P-65005 8024 04																																																																																																				
11,0 × 30,0	P-65005 8024 03																																																																																																				
10,7 × 30,7	64203 3 107307																																																																																																				
11,2 × 31,2	64203 3 112312																																																																																																				
11,7 × 26,7	64203 3 117267																																																																																																				
12,2 × 27,2	64203 3 122272																																																																																																				
11,7 × 30,7	64203 3 117307																																																																																																				
12,2 × 31,2	64203 3 122312																																																																																																				